

# TILE LEVEL QUICK

PROFESSIONAL

SISTEMA RÁPIDO DE NIVELACIÓN / FAST LEVELING SYSTEM / SYSTÈME RAPIDE DE PRISE DE NIVEAU / SISTEMA RÀPID D'ANIVELLAMENT / SISTEMA RÁPIDO DE NIVELAMENTO / SISTEMA RAPIDO DI LIVELLO / SCHNELLE NIVELLIERSYSTEME / SNEL NIVELLERINGSSYSSTEEM / SYSTEM SZYBKIEGO POZIOMOWANIA / БЫСТРАЯ СИСТЕМА НИВЕЛИРОВКИ / LAATANTASAUJÄRJESTELMÄ / RYCHLÁ VYROVNÁVACÍ SYSTÉM / SISTEM DE NIVELARE RAPIDA / 瓷砖快速平整仪 / KIIRE TASANDAMINE SÜSTEEMI / GYORS SZINTEZÉSI RENDSZER / GREITA IŠLYGINIMO SISTEMA / БЪРЗА СИСТЕМА ЗА НИВЕЛАЦИЯ НА ПЛОЧКИ

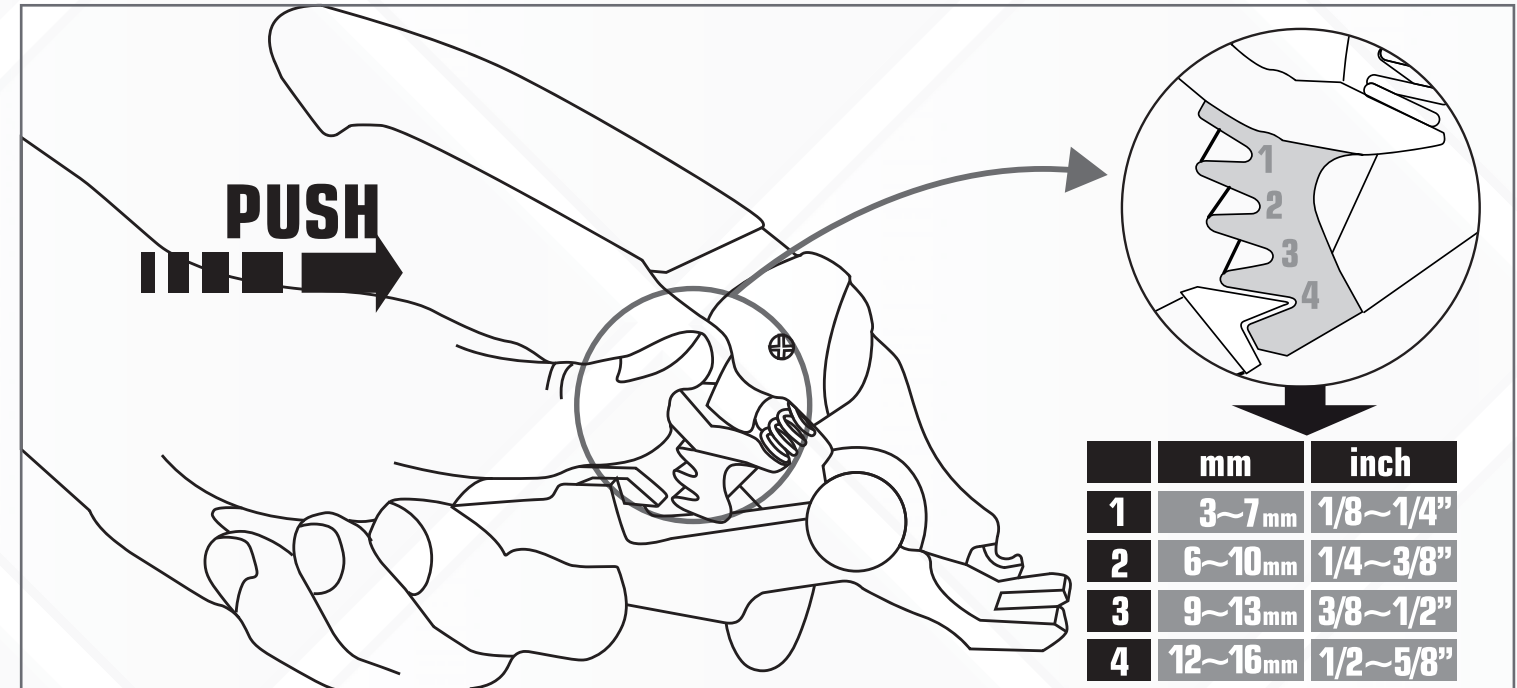
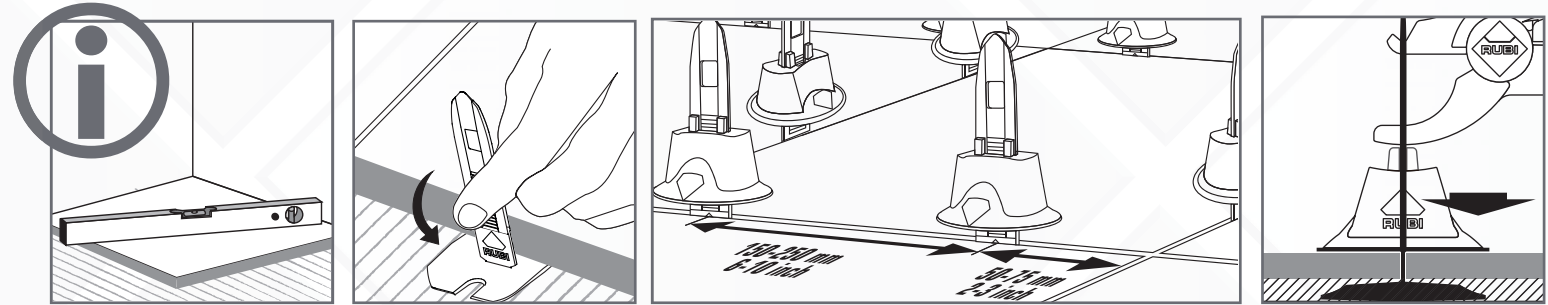
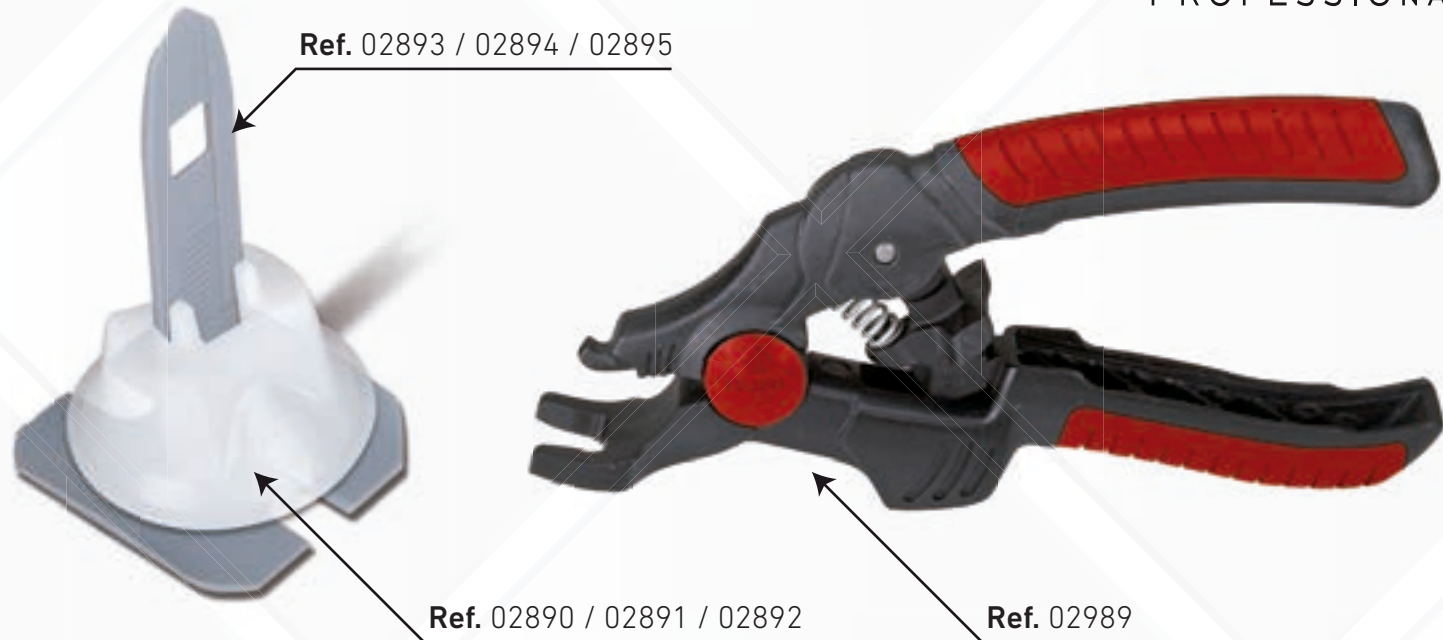

# KIT TILE LEVEL QUICK

PROFESSIONAL

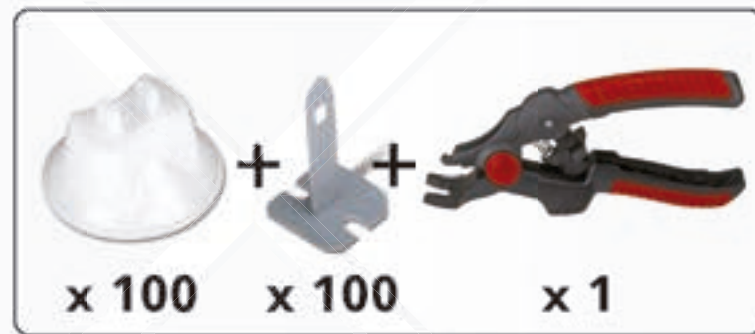

Ref. 02941

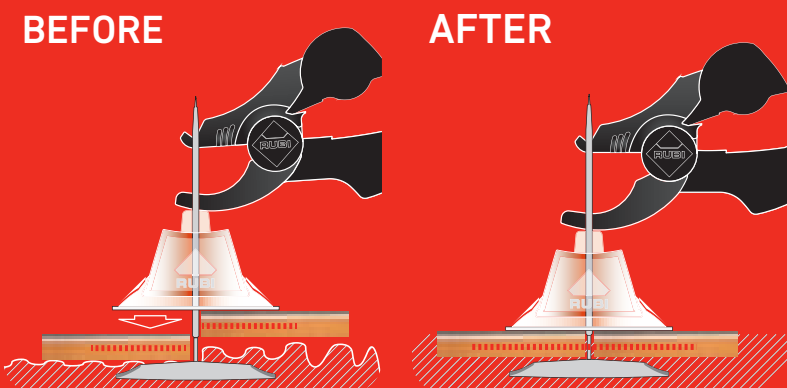
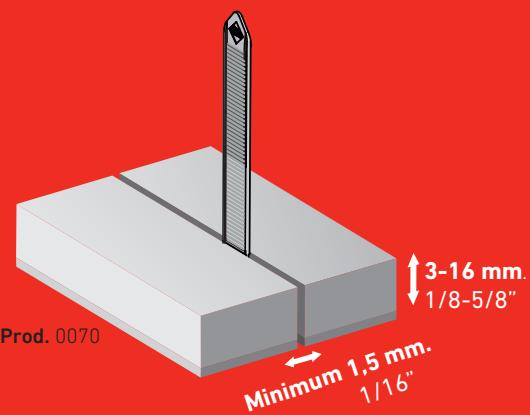
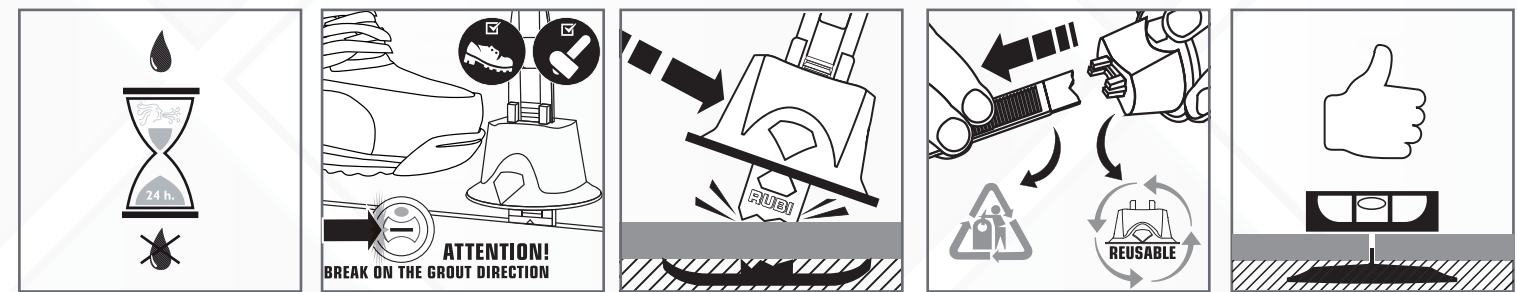

| cm/inches           | 30x30<br>12"x12" | 33x33<br>13"x13" | 40x40<br>16"x16" | 45x45<br>18"x18" | 50x50<br>20"x20" | 60x60<br>24"x24" | 80x80<br>32"x32" | 60x30<br>24"x12" | 100x50<br>40"x20" | 120x60<br>48"x24" |
|---------------------|------------------|------------------|------------------|------------------|------------------|------------------|------------------|------------------|-------------------|-------------------|
| u. / m <sup>2</sup> | 42               | 36               | 20               | 28               | 24               | 10               | 10               | 22               | 16                | 10                |
| u. / sq.ft          | 4                | 4                | 2                | 2,5              | 2                | 1                | 1                | 2                | 1,6               | 1                 |

|       |       |     |       |       |     |      |       |      |    |  |
|-------|-------|-----|-------|-------|-----|------|-------|------|----|--|
|       | Ref.  | x   | u.    | Ref.  | x   | u.   |       |      |    |  |
|       | 02893 | 100 | 6     | 02890 | 100 | 10   |       |      |    |  |
|       | 02894 | 200 | 12    | 02891 | 200 | 15   |       |      |    |  |
| 02895 | 400   | 6   | 02892 | 400   | 8   | Ref. | u.    | Ref. | u. |  |
|       |       |     |       | 02989 | 1   |      | 02941 | 1    |    |  |